

## Installation instructions for using MIW-SURGE with SIGNAL LINE CONNECTION OPTIONS

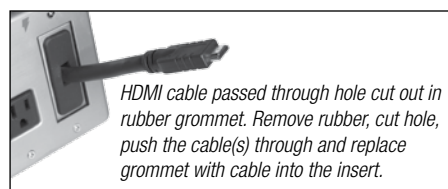

**1. PASS THROUGH INSERT** with rubber grommet accommodates HDMI, RGB, or coaxial cables.



**2. KEYSTONE 2 PORT ADAPTER INSERT** with module selection. NOTE: If using a punchdown connector, punch down wires first before inserting module into KEYSTONE insert. (Modules for KEYSTONE adapter insert are sold separately and **not** available from PFPower)

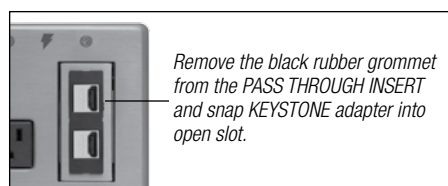

**3. DECORA TRIM ADAPTER** for 6 port insert for a variety of signal line connections. (6 port insert and modules are sold separately and **not** available from PFPower)

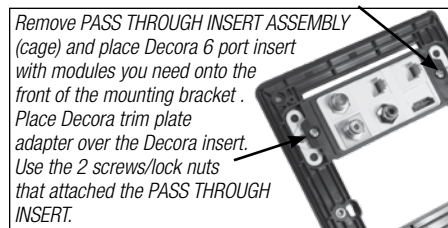

### 4. MIW PRO SIGNAL LINE MODULES

Four module types available.  
1. MIW-RCA 2. MIW-VGA  
3. MIW-SVIDEO 4. MIW-DATA.  
(Modules not included, sold separately and available from PFPower, see below for module descriptions).

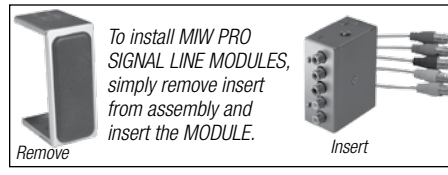

### MIW PRO SIGNAL LINE MODULES

The MIW Pro Signal Line modules give you 4 options to choose from. Each signal line module comes with an instructions for easy install.

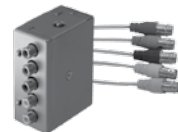

**1. MIW-5RCA**  
Low voltage module with 5 RCA connections compatible with component video or composite audio/video signal.

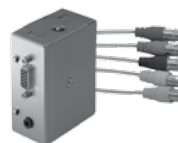

**2. MIW-VGA**  
Low voltage module for RGBHV; connect devices to 15 pin high-density D-sub connector on face of module; 3.5mm stereo mini-jack for 12-volt triggering and IR signal transmission.

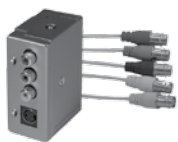

**3. MIW-SVIDEO**  
Combination S-Video and Component Video, low voltage module for video and/or audio, RCA jacks compatible with audio or video signals.



**4. MIW-DATA**  
RS232 and Ethernet, low Voltage module for projector control lines and/or computer data lines.

### Adjustable 3 depth settings for:

- PASS THROUGH INSERT
- KEYSTONE ADAPTER
- ALL 4 MIW PRO SIGNAL LINE MODULES.

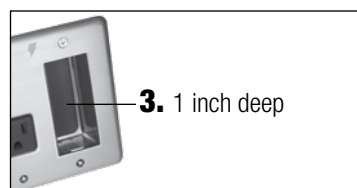
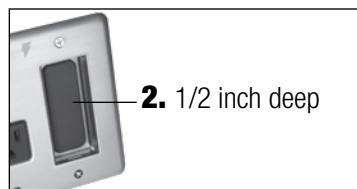
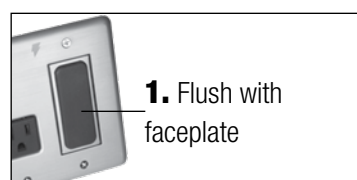

The MIW Pro Signal Line modules are not included and sold separately from PFPower. Contact Panamax or Furman to order module(s) and other products you may need.

## PRODUCT SPECIFICATIONS

AC Circuit  
AC Outlets, Total: .....1  
Line Voltage: .....120V, 50/60Hz  
Total Current Capacity: .....15A  
Protection Modes: .....L-N, L-G, N-G  
Energy Dissipation: .....1350 Joules  
Peak Impulse Current: .....60 KA  
Catastrophic Surge Circuit: .....Yes  
Thermal Fusing: .....Yes  
UL 1449 2nd Ed. Suppressed Voltage Rating: .....330 V (@500A)  
UL 1449 3rd Ed. Voltage Protection Rating: .....400 V (@3,000A)  
UL 1449 3rd Ed. Nominal Discharge Current: .....5,000A  
Power Outlet Faceplate  
AC Connectors: .....1 NEMA 5-15  
Signal Line Protection: Not Included / Modules Sold Separately

**CAUTION:** USE ONLY IN DRY (INDOOR) LOCATIONS.  
**ATTENTION:** PAR L'USAGER A L'INTERIEUR.  
WALL MOUNTING THICKNESS 3/8" - 5/8"

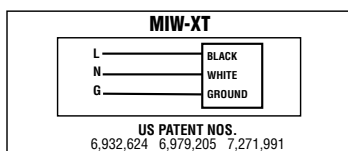
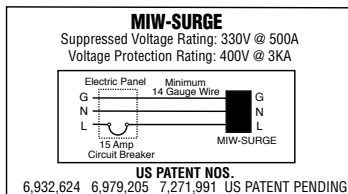

## WARRANTY

PFPower warrants to the purchaser of any PFPower In-Wall surge protector, for a period of 3 years from its installation date, that the surge protector shall be free of defects in design, material, or workmanship, and PFPower will repair or replace any defective unit. For product replacement see "NOTIFICATION" below.

**CAUTION:** Audio/Video, computer and/or telephone system installations can be very complex systems, which consist of many interconnected components. Due to the nature of electricity and surges, a single protector may not be able to completely protect complex installations. In those cases, a systematic approach using multiple protectors must be employed. Systematic protection requires professional design. AC power, satellite cables, CATV cables, or telephone/network lines entering the system that do not pass through this surge protector will provide pathways for potential surge damage. For additional information on how to protect your system, please contact PFPower before connecting your equipment to the surge protector. More detailed information is available at [www.panamax.com](http://www.panamax.com) or [www.furmansound.com](http://www.furmansound.com). If you have any questions regarding these requirements, please contact PFPower Customer Relations.

**1. PROPER INSTALLATION:** PFPower In-Wall AC and Signal-line protectors are

designed to provide code-compliant (NEC or CEC) installations. Separate signal-line protection modules must be used with the appropriate AC base unit to provide proper grounding. Building wiring and other connections to protected equipment must conform to applicable codes (NEC or CEC). No other ground wires or ground connections may be used. All wires (including, AC power lines, telephone lines, signal/data lines, coaxial cable, antenna leads) leading into the protected equipment must first pass through a single PFPower protector designed for the particular application. The protector and the equipment to be protected must be indoors in a dry location, and in the same building. PFPower installation instructions and diagrams must be followed.

**2. NOTIFICATION:** You must obtain a return authorization (RA) number from the PFPower Customer Relations Department at [www.panamax.com](http://www.panamax.com) or [www.furmansound.com](http://www.furmansound.com) or toll-free at 1-800-472-5555 before returning the protector to PFPower. Once you obtain an RA number, please mark the number on the bottom of the unit and pack it in a shipping carton/box with enough packing material to protect it during transit. The RA number must be clearly marked on the outside of the carton. Ship the unit to PFPower. Please note that you are responsible for any and all charges related to shipping the unit to PFPower.

**3. DETERMINATION OF FAILURE:** PFPower will evaluate the protector for defects. Opening the enclosure, tampering with, or modifying the unit in any way shall be grounds for an automatic denial of your request for replacement. PFPower, after evaluating the unit, shall in its sole discretion, determine whether or not your protector is eligible for replacement. If the surge protector shows no defects, PFPower will return the unit to you with a letter explaining the test results. Exception: If a dealer or installer replaces the protector for the customer, the unit will be returned to the dealer or installer.

**4. GENERAL:** If you have any questions regarding the product warranty, please contact the Customer Relations Department at [www.panamax.com](http://www.panamax.com) or [www.furmansound.com](http://www.furmansound.com) or toll-free at 1-800-472-5555. This warranty supersedes all previous warranties. This is the only warranty provided with the protector and any other implied or expressed warranties are non-existent. This warranty may not be modified except in writing, signed by an officer of PFPower. Forms are available on the Panamax or Furman web sites for requesting RA's.

MODEL - MIW-SURGE  
DOC. NO. Q01L0047\_EN REV. A  
Effective Date 6/08



PFPower, 1690 Corporate Circle • Petaluma, CA 94954  
707-283-5900 • 800-472-5555 • Fax - 707-283-5901  
[www.panamax.com](http://www.panamax.com) • [www.furmansound.com](http://www.furmansound.com)

Customer Relations  
7:30 AM – 4:30 PM, M-F, Pacific Time (PST)  
Email - [custrelations@panamax.com](mailto:custrelations@panamax.com)



# MIW-SURGE Installation Instructions

The MIW-SURGE is designed essentially for compatibility with three basic configurations:

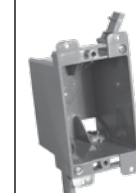

**1.** Single gang plastic outlet box, retro



**2.** Single gang metal outlet box, new work

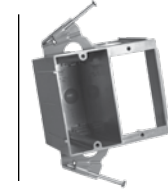

**3.** Dual gang plastic outlet box, new work

Outlet boxes are **NOT** included and are sold separately.

### PARTS INCLUDED:



**1.** MIW-SURGE metal outlet faceplate (AC receptacle attached)



**2.** 4 flathead faceplate screws and 2 pan head screws for bracket



**3.** MIW-SURGE plastic mounting bracket

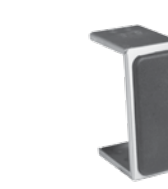

**4.** MIW pass through removable and adjustable insert with rubber grommet (comes attached to mounting bracket)



**5.** Decora® trim plate adapter



**6.** Keystone module insert



**7.** 11" Flat Plug adapter power cord



**8.** Three wire twist nuts



**9.** Wall cut out template 3 3/4" H x 4" W

### TOOLS RECOMMENDED:

- Drywall saw or Dremel tool (to cut outlet box hole)
- Hand held or power screw driver with Phillips head
- File (optional) to smooth and shape the outlet box cutout (if necessary)
- Utility knife
- Combination strippers
- Long nosed pliers





# BEFORE YOU GET STARTED

Determine which outlet box for AC power and signal line connections your installation requires.

## CAUTION

Only use with 15 Amp branch circuits utilizing 14 or 12 gauge wire. Make sure the branch circuit is de-energized before installation.

### Installation instructions for using MIW-SURGE with SINGLE GANG PLASTIC OUTLET BOX - RETRO

#### Materials Required

- MIW-SURGE unit
- Outlet box, Carlon B114R (plastic retro-fit) not included, sold separately



**1.** Determine where to place the MIW-SURGE. Locate where the unit is to be installed and trace the outline of the cutout hole with the included template. (3 3/4" H x 4" W) for the plastic single gang.

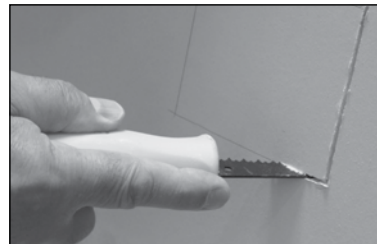

**2.** Using drywall saw, cut out opening along the drawn lines. If necessary use a file to enlarge the opening.

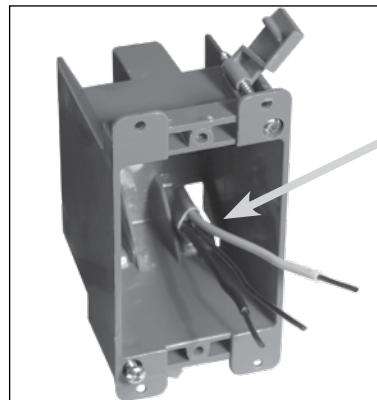

**3.** Bend the two lower wire clamps down on the bottom, rear of the box to make clearance for the MIW-SURGE and for Romex cord.

**4.** Pull through Romex cord and dress accordingly. No more than 1" of sheath should extend into the outlet box. 2" to 3" of the hot, neutral and ground wires should extend beyond that.

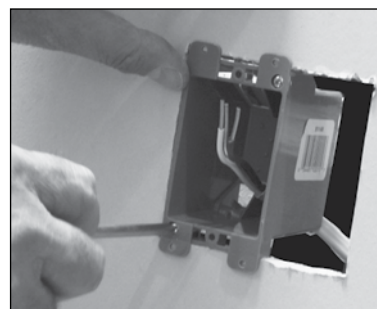

**5.** Insert the single gang plastic outlet box into the left-hand side of the hole and secure the drywall clamps.

2

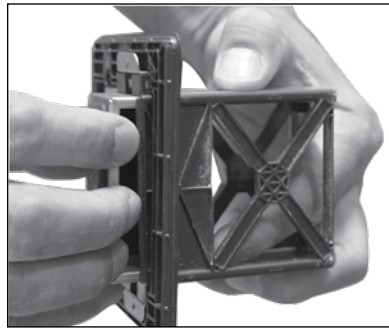

**6.** Before attaching the MIW-SURGE mounting bracket, determine which signal line connection is to be utilized. Remove or adjust the depth of the insert, or the entire insert assembly if needed. For signal line instructions, see **Panel 5 for SIGNAL LINE CONNECTION OPTIONS.**

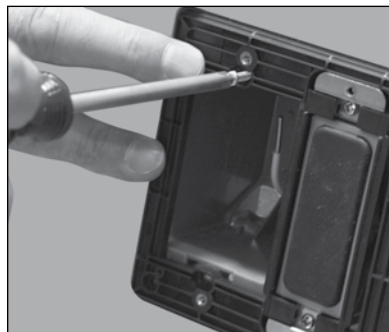

**7.** After the signal line connection is completed, attach the MIW-SURGE plastic mounting bracket to the outlet box with the two panhead screws.

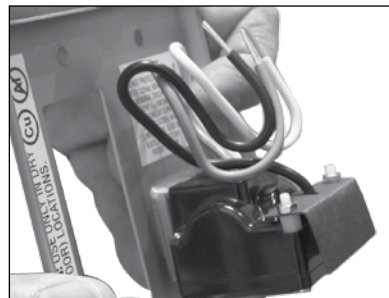

**8.** Fold the wires as shown to help make clearance for the faceplate assembly to fit into outlet box.

**9.** Twist the hot (black), neutral (white) and ground (green) wires from the MIW-SURGE to the three corresponding stripped wires from the Romex. Connect the splices with the included yellow wire nuts.



**10.** Attach the MIW-SURGE faceplate to the mounting bracket with the 4 flat head screws.



**11.** Plug in the Flat Plug AC cord to be connected to equipment. The picture shown here indicates using the HDMI cable as an example only (Many different options are available).

3

### Installation instructions for using MIW-SURGE with SINGLE GANG METEL OUTLET BOX - NEW WORK

#### Materials Required

- MIW-SURGE unit
- Metal outlet box, Raco 8355 (not included, sold separately).

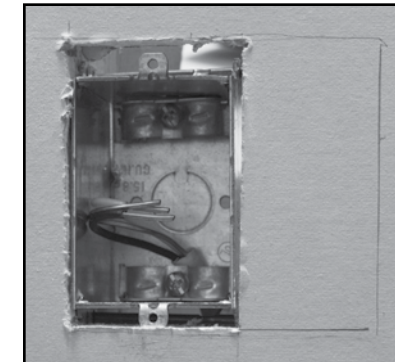
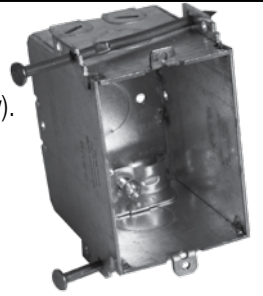

**1.** It's most likely the metal outlet box is already installed in the wall as shown here. Using the template, align the left side of the existing cutout hole with the left edge of template and draw a line around the template. The total width of the cut out hole should be 4" across.

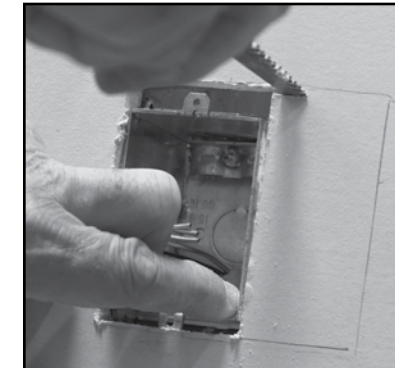

**2.** Using the drywall saw, cut along the line to enlarge the cut out hole.

**3.** Follow STEPS 3 through 11 from the SINGLE GANG PLASTIC OUTLET BOX instructions to install the MIW-SURGE.

### Installation instructions for using MIW-SURGE with DUAL GANG PLASTIC OUTLET BOX - NEW WORK

#### Materials Required

- MIW-SURGE unit
- Carlon dual gang plastic outlet box, (not included, sold separately).

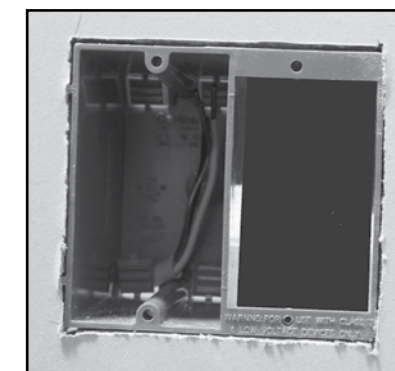

**1.** Most likely the dual gang outlet box is already installed in the wall as shown here.

**2.** Follow STEPS 3 through 11 from the SINGLE GANG PLASTIC OUTLET BOX instructions to install the MIW-SURGE.

4